



Alfa Laval TJ40G

Rotary jet heads

Introduction

The Alfa Laval TJ40G range of rotary jet head tank cleaning machine for hygienic environments. Built to clean tanks with capacities from 150-2250m³ it combines pressure and flow to create high-impact cleaning jets that rotate in a repeatable and reliable 360-degree cleaning pattern.

The TJ40G range minimizes the consumption of water and cleaning media. Easy to customize to meet customer requirements, it allows companies to spend less time cleaning and more time producing.

Application

The Alfa Laval TJ40G range is designed for the removal of the toughest residues from hygienic tanks across a broad range of industries, such as the dairy, food, beverage, brewery, distillery*, pharmaceutical and personal care industries.

Benefits

- 60% faster cleaning = more time for production
- Saves up to 70% of your cleaning cost
- Eliminates the need for confined space entry for manual tank cleaning
- High-impact cleaning in a 360° repeatable cleaning pattern
- Cleaning process can be validated using Alfa Laval Rotacheck
- Heavy-duty (HD) version can handle re-circulation of larger particles in the cleaning liquid*
- Burst version with fast chemical wetting reduces cleaning time and costs

Standard design

The choice of nozzle diameters can optimize jet impact length and flow rate at the desired pressure. These special versions are available:

- **Alfa Laval TJ40G-HD** for applications where larger amounts of particles in the cleaning liquid are re-circulated over the machine. Its special design ensures that particles do not get trapped inside the machine or damage / block the machine during operation.
- **Alfa Laval TJ40G Burst** with a special burst nozzle design for fast chemical wetting of the tank. Burst cleaning reduces cleaning cycle time and the use of water and chemicals. For more information, see the separate datasheet about the burst technique.

Alfa Laval offers a wide range of tank cleaning machines suitable for different duties and industries. An alternative that offers performance similar to the Alfa Laval TJ40G range is the Alfa Laval GJ 8 or Alfa Laval GJ 4 for applications that require a small tank inlet opening.

Working principle

The high-impact jet stream from the Alfa Laval TJ40G rotary jet head range is designed to cover the entire surface of the tank interior in a successively denser pattern. This achieves a powerful mechanical impact with a low volume of water and cleaning media.

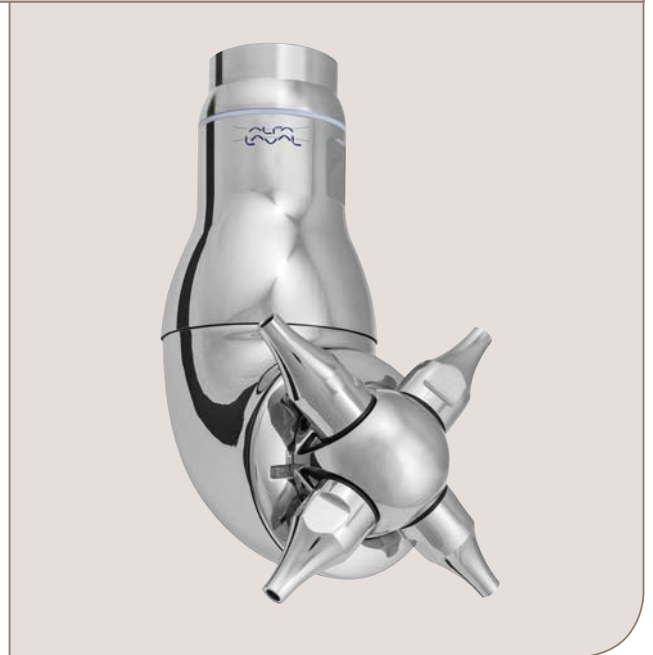

The flow of the cleaning fluid makes the nozzles perform a geared rotation around the vertical and horizontal axes. In the first cycle, the nozzles lay out a coarse pattern on the tank surface. The subsequent cycles gradually make the pattern denser until at full cleaning pattern is reached. Once the full cleaning pattern is reached, the machine will start over again and continue to perform the next full cleaning pattern.

* Heavy-duty distillery version can handle re-circulation of larger particles in the cleaning liquid.

Cleaning Pattern

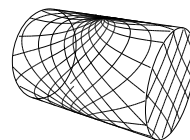

First cycle

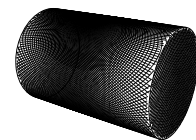

Full pattern

The above drawings show the cleaning pattern achieved on a cylindrical horizontal vessel. The difference between the first cycle and the full pattern represents the number of additional cycles available to increase the density of the cleaning.

Certificates

2.2 material certificate, Q-doc and ATEX



TECHNICAL DATA

Lubricant:	Cleaning liquid
Surface finish	
Standard Surface finish:	Exterior surface finish Ra 0.5µm
Interior surface finish:	Ra 0.8µm
Throw length	
Max throw length (5 bar):	21.5 m
Impact throw length (5 bar):	10.5 m
Pressure	
Working pressure:	3-12 bar
Recommended pressure:	5-7 bar

PHYSICAL DATA

Materials	
AISI 316, SAF 2205, PFA*, PEEK*, EPDM*	
* FDA compliance 21CFR§177	
Temperature	
Max. working temperature:	95°C
Max. ambient temperature:	140°C
Weight	
Weight:	6.3 kg.

Caution

Avoid hydraulic shock, hard and abrasive particles in the cleaning liquid, as this can cause increased wear and/or damage of internal mechanisms. For low amount of particles in the cleaning media a 3mm strainer is recommend for both the TJ40G and TJ40G-HD For high amount of particles in the cleaning media a 0.1mm strainer (TJ40G) and 1mm (TJ40G-HD) is recommended Do not use for gas evacuation and air dispersion

	TJ40G	TJ40G Burst	TJ40G-HD	TJ40G-HD Burst
4xø6				
fast	15.8	20.8	17.5	22.5
4xø6	15.8	20.8	17.5	22.5
4xø6,6	18.2	23.2	20.0	25.0
4xø7,3	20.9	25.9	22.5	27.5
4xø8,1	24.9	29.9	26.5	31.5
4xø9	29.1	34.1	31.0	36.0
4xø10	33.8	38.8	35.5	40.5
4xø11	39.0	44.0	41.0	46.0
2xø10	19.2	21.7	20.3	22.8
2xø11	22.4	24.9	23.4	25.9

Qualification Documentation

Documentation specification

	Equipment Documentation includes:
	- EN 1935/2004 DoC
	- EN 10204 type 3.1 inspection Certificate and DoC
Q-doc	- FDA DoC
	- GMP EC 2023/2006 DoC
	- EU 10/2011 DoC
	- ADI DoC
	- QC DoC
ATEX	ATEX approved machine for use in explosive atmospheres.
	Category 1 for installation in zone 0/20 in accordance with directive 2014/34/EU
	II 1G Ex h IIC 85°C ...175°C Ga
	II 1D Ex h IIIC T85°C ...T140°C Da

Flow rate

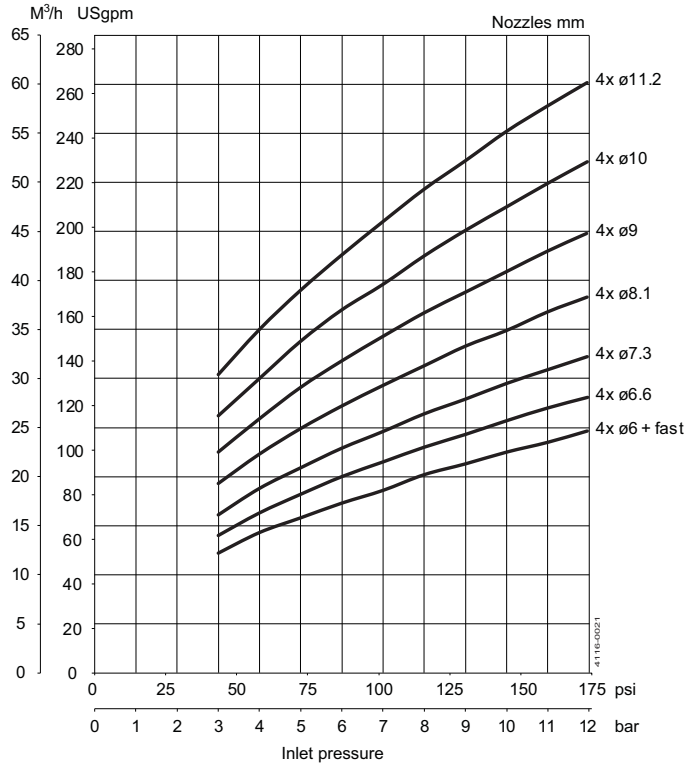

Impact throw length

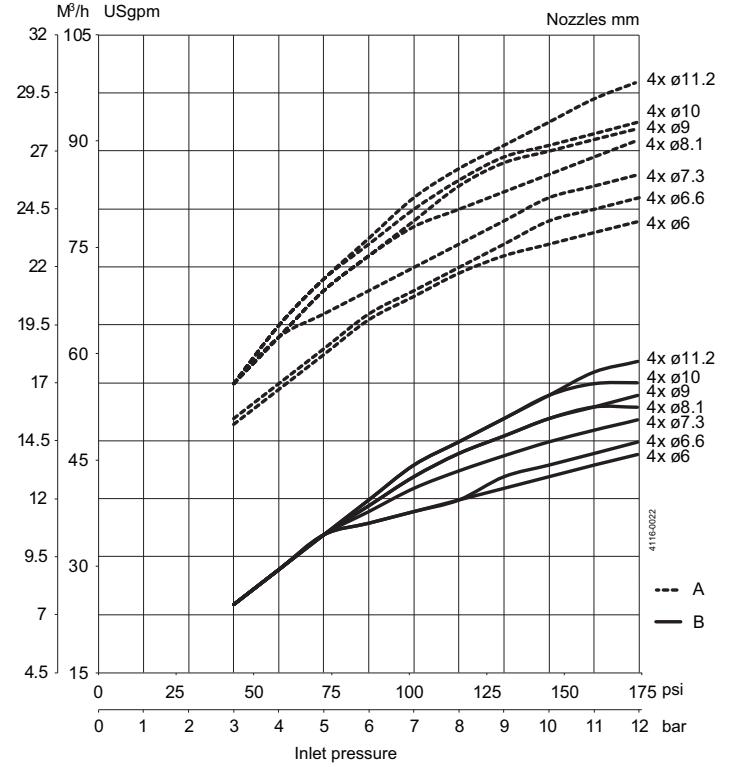

Throw length measured according to tech. specification 93P003

Cleaning time for complete pattern (= 8 cycles)

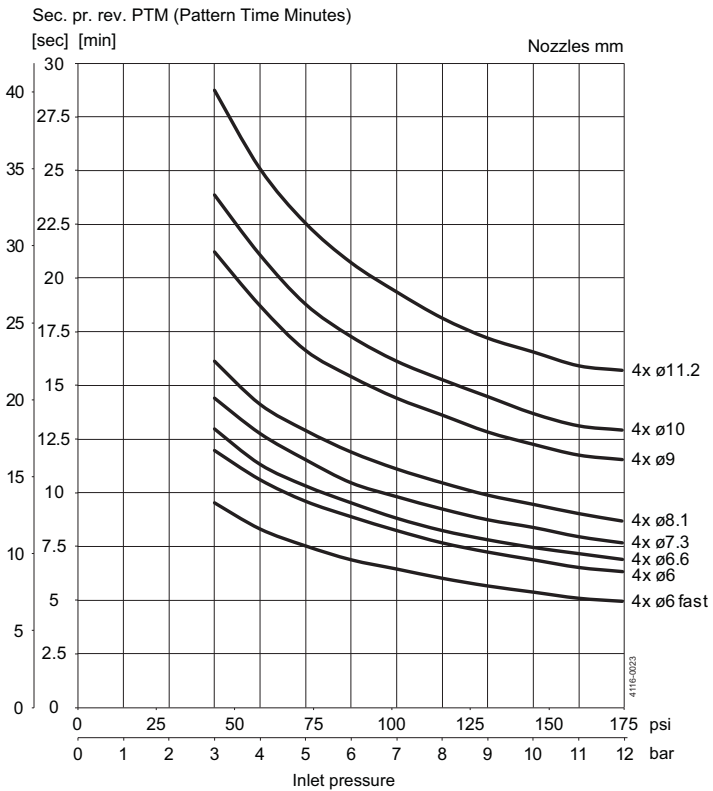

Burst cleaning version has a 20-25% faster complete pattern

Dimensions

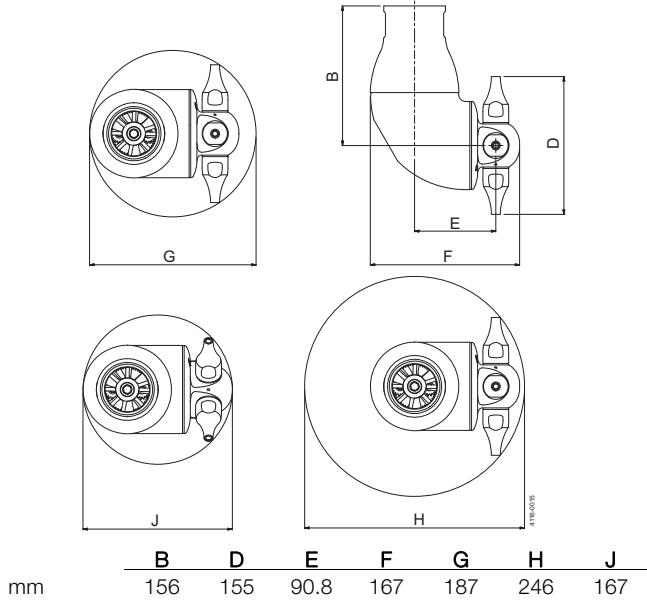

TRAX simulation tool

Wetting Intensity

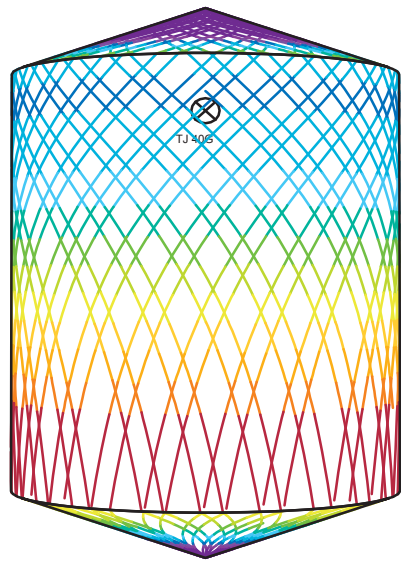
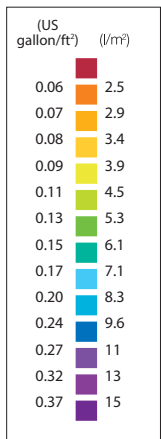

D4.6m H5.5m, Toftejorg TJ40G, 4 x \varnothing 7.3 mm, Time = 2 min., Water consumption = 700 l

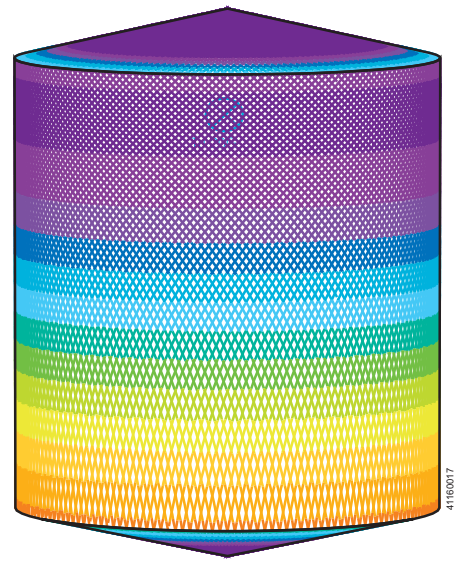

D4.6m H5.5m, Toftejorg TJ40G, 4 x \varnothing 7.3 mm, Time = 16 min., Water consumption = 5600 l

Alfa Laval reserves the right to change specifications without prior notification.

How to contact Alfa Laval
 Contact details for all countries are continually updated on our website. Please visit www.alfalaval.com to access the information direct.